

Maximale Belastung für Wannengriffe 100Kg
(Befestigungslöcher müssen senkrecht gebohrt werden)

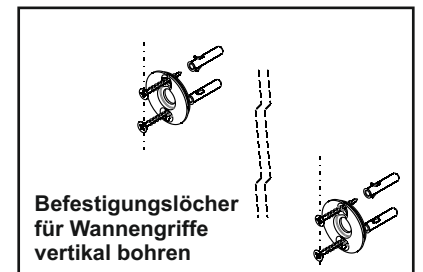

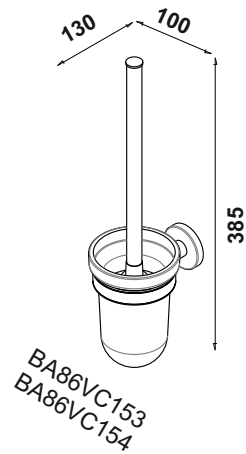

BA86xx821

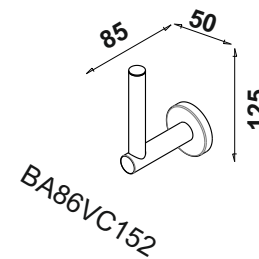
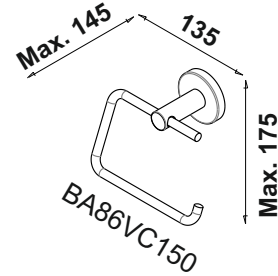
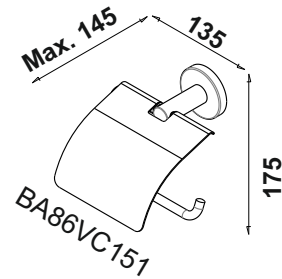
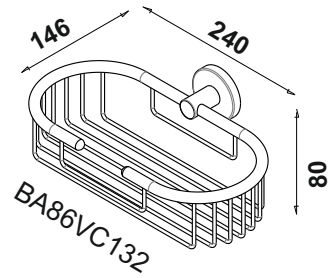
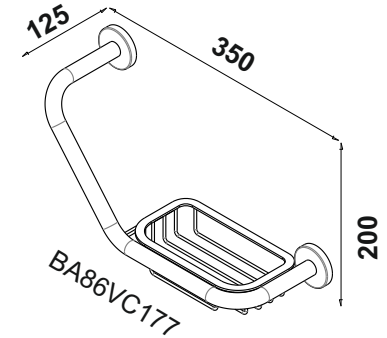
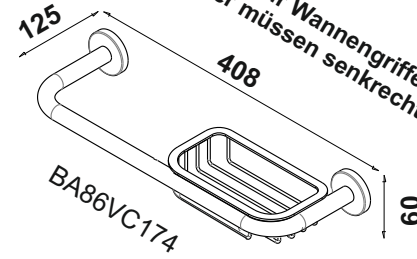
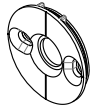
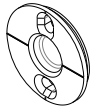

BA86xx822
Wannengriffe/grab bars



BA 81xx826

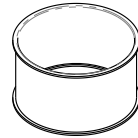

BA86xx825

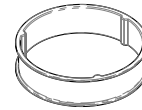

BA 81xx827

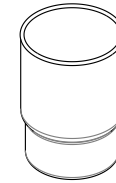

BA19xx801
BA19xx802

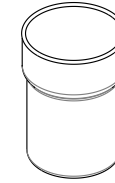

BA86xx801
BA86xx802

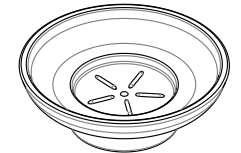

BA81xx805
BA84xx806

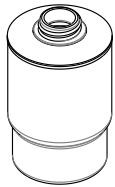

BA56xx881
BA56xx882

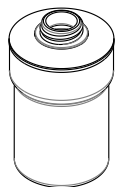

BA86xx881
BA86xx882

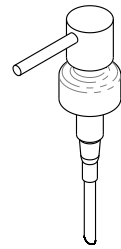

BA56vc831

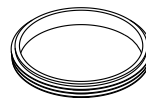

BA56xx833

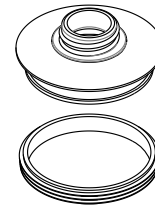

BA56vc880

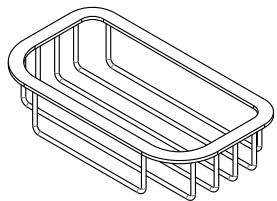

BA40vc852



BA81xx830



BA40XX861

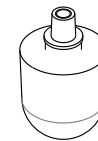

BA40xx863

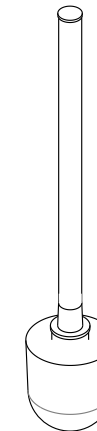

BA40vc862

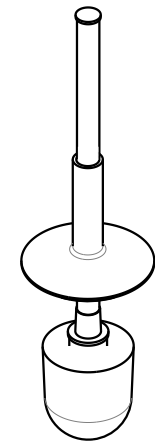

BA40vc856